



# VAYA



# FB-2 E-BIKE

---

USER GUIDE  
PO-1697

# CONTENTS

GENERAL .....	4
SYMBOL EXPLANATION.....	4
BEFORE YOU START .....	4
WARNING .....	5
IMPORTANT SAFETY INSTRUCTIONS.....	5
WARNING - DANGER.....	5
WARNING.....	5
CAUTION .....	5
NOTE.....	6
WARNING.....	6
BOX CONTENT .....	6
ASSEMBLY.....	7
FRONT WHEEL ASSEMBLY.....	7
SEAT ASSEMBLY.....	7
HANDLEBAR ASSEMBLY .....	8
PEDAL ASSEMBLY.....	9
FRAME FOLDING MECHANISM.....	9
SAFETY LOCK .....	9
FOLDING INSTRUCTIONS .....	10
FOLDING THE BIKE .....	10
LCD DISPLAY .....	13
OPERATING PRINCIPLES .....	13
SETTINGS.....	14
MAIN MENU.....	14
DISPLAY SETTINGS .....	14
ADVANCED SETTINGS .....	14
INFORMATION .....	15
PASSWORD.....	15
GEAR SHIFTER.....	15
DRIVING MODES.....	15
PEDAL-ASSIST MODE.....	15
PEDAL MODE.....	16
WALK-ASSIST MODE.....	16
BIKES WITH HAND THROTTLE.....	16
USING THE E-BIKE.....	16
SEAT HEIGHT.....	16
SEAT ADJUSTMENT .....	16
STEM HEIGHT .....	16
HAND BRAKES.....	16
TIGHTENING OF FASTENERS.....	16
SUSPENSION ADJUSTMENT .....	17
PRECAUTIONS BEFORE DRIVING.....	17
LOCK.....	17
WEIGHT AND SPEED LIMITS .....	18
WEIGHT RESTRICTIONS .....	18
OPERATING RANGE.....	18
BATTERY INFORMATION AND SPECIFICATIONS .....	18
REMOVING THE BATTERY .....	19
INSERTING THE BATTERY.....	19
BATTERY SPECIFICATIONS .....	19
BATTERY STORAGE .....	20
CHARGING THE BATTERY.....	20
SAFETY TIPS FOR CHARGING .....	20
CHARGER SPECIFICATIONS.....	21
INSPECTION, MAINTENANCE, AND STORAGE.....	21
INSPECTING YOUR E-BIKE.....	21
CLEANING YOUR E-BIKE .....	22
CHAIN MAINTENANCE .....	22
STORING YOUR E-BIKE.....	22
ADJUSTING THE REAR DERAILLEUR .....	22
HYDRAULIC BRAKES .....	24
NOISE FROM BRAKES .....	24

THE BRAKES ARE NOT WORKING .....	24
INSPECTING THE TRUENESS OF THE WHEELS.....	24
INSPECTING THE WHEEL BEARINGS .....	24
REMOVING A WHEEL.....	24
CHANGING AN INNER TUBE.....	25
REPLACING THE BRAKE PADS .....	25
E-BIKE SPECIFICATIONS .....	25
RECOMMENDED TORQUES .....	26
DISPLAY ERROR MESSAGE .....	26
DISPOSAL .....	27

## GENERAL

READ CAREFULLY BEFORE USE.

## SYMBOL EXPLANATION

The A-weight emission sound pressure level at the driver's ears is less than 70 dB(A)



For indoor use only



This unit is double insulated



Wear personal protective equipment



Read manual before operating the product



Class III protection against electric shock.



The center (tip) of the output plug is positive (+) and the barrel of the output plug is negative (-).



For safe and proper use, follow these instructions.  
Keep this user manual for future reference.

## BEFORE YOU START

Before you use the e-bike for the first time, please read the **USER MANUAL** thoroughly and follow the instructions and warnings to ensure your safety and the safety of others. It is recommended to keep the instruction manual for future reference.

For further information, visit [www.vayabike.com](http://www.vayabike.com)

## **WARNING**

Failure to follow the basic instructions and safety precautions listed in the USER MANUAL can lead to damage to your scooter, other property damage, serious personal injuries, and even death.

The e-bike is designed for “city and trekking”, so use the bike only on roads and even pathways. Using the bike on other surfaces or in other ways can result in system failure and loss of control, leading to serious personal injuries or death.

As with all mechanical components, the bike is subject to normal wear and tear. Different materials and components can behave differently due to wear and tear. If components' lifetime is exceeded, they can suddenly fail or break, resulting in injuries to the user. Any form of crack, scratch or change in colour of components is a sign that the component is worn out and is in need of replacement.

## **IMPORTANT SAFETY INSTRUCTIONS**

### **WARNING - DANGER**

1. Children should be supervised to ensure that they do not play with the appliance. Cleaning and user maintenance should not be done by children.
2. The battery charger may be used by children aged 8 years and above and persons with reduced physical, sensory or mental capabilities or lack of experience and knowledge provided that they have been given supervision or instruction regarding the use of the appliance in a safe way and provided they understand the hazards involved.
3. Do not attempt to modify, change or open your battery.
4. Do not place the battery near any heat sources such as heaters. The battery must not be heated or exposed to open flames.
5. Do not subject the battery to heavy impact or throw it.
6. Do not submerge the battery in water or let the battery connector become wet.
7. Do not insert the battery if the battery connector on the e-bike is wet. Place the e-bike inside and make sure that the connector on the e-bike is completely dry before inserting the battery.
8. Do not leave the battery in direct sunlight. Do not leave the battery in a vehicle during high temperatures or in other warm locations. This can cause battery leakage.
9. Only use the charger included in the box. The e-bike must only be supplied with safety extra low voltage corresponding to the marking on the e-bike's battery.
10. Do not exceed the maximum weight limit (150 kg).

### **WARNING**

1. Do not charge the battery outside or in areas with high humidity.
2. Do not use the battery if it is visibly damaged.
3. Ensure that the wheels are mounted correctly before riding the bike.
4. Learn how to ride and use all functions of the e-bike before using it in traffic.
5. Check that the front light works before riding the e-bike in darkness.
6. Always remove the battery before performing any maintenance or installation work on the e-bike.
7. If the charger supply cord is damaged, it must be scrapped, and the charger must be replaced by the manufacturer or its service agent – please contact the service line.
8. The included charger is only to be used for this e-bike and not for any other electronic equipment. Do not use the charger to charge any non-rechargeable batteries.
9. Do not abuse your e-bike; doing so can damage your unit and cause failure to the operating system which can lead to injuries.
10. Do not ride the e-bike using loose or torn clothing.
11. Safety-critical components should be replaced using genuine replacement parts.
12. Please be aware of the specific risk of entrapment during normal use and maintenance on the front/rear wheel, chain and sprocket.

### **CAUTION**

1. Please wear all appropriate safety and protective gear while operating the e-bike. See the operating principles section for more information.
2. Do not operate the e-bike while under the influence of drugs and/or alcohol.
3. Brakes can get hot after use: do not touch them after braking.
4. If the handlebar grips become damaged and expose the metal ends of the handlebar, these

- must be capped using internally fitted “bar end plugs”.
5. Do not ride in extreme weather, such as heavy snow, rain, hail, sleet, on icy surfaces or in extreme heat.
  6. The fording depth should not exceed 80 mm.
  7. Do not immerse this bike in water.
  8. Do not ride this bike up and down steps.
  9. Do not operate the e-bike while talking, texting, or looking at your phone.
  10. At high speeds, always take into consideration longer stopping distances.
  11. Please note possible increased braking distance in wet weather.
  12. Do not clean your bike with a pressure washer. High-pressure cleaning may remove lubricant and/or grease from bike parts.
  13. When lubricating the moving parts of the e-bike, take care not to get any lubricant on the brake discs or brake pads.

## NOTE

1. Disassembling the e-bike will void your warranty.
2. PAY ATTENTION - look where you are riding and be aware of the surface conditions, people, places, property, and objects around you.
3. When operating the e-bike in the dark, be sure to follow the laws regarding rear and front lights and correct reflectors. Supplied light is for additional lighting only.
4. Do not ride the e-bike where it is not permitted. Check the limitations of use according to road safety regulations.
5. These instructions are available from the service address at the bottom of the page.

The instructions must be read and understood by each rider before use. Retain them for future reference and pass them on to any new owner or rider of the e-bike.

It is recommended to keep the original box in the unlikely event that you need to return the product to us or send it in for repair.

## WARNING

The warranty does not cover improper use of the product or the failure of users to follow the warnings and operating instructions in this user manual. There is a limited warranty on wearable parts, such as tyres, battery, motor, chain, cassette, brakes, and handle grips. These parts are considered wear parts and can be ordered at [www.vayabike.com](http://www.vayabike.com). See the service folder for more information.

## BOX CONTENT



E-bike

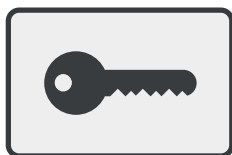

2 x keys

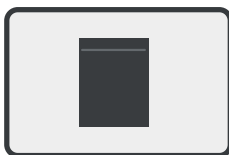

Bag with tools

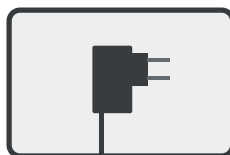

Charger

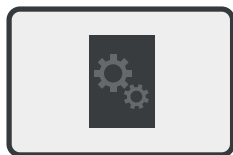

Manual

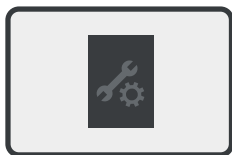

Service folder

## ASSEMBLY

**WARNING:** Read the manual before using the bike for the first time.  
See the section “Recommended torques” for correct tightening of bolts and screws.

### FRONT WHEEL ASSEMBLY

Remove the protective pre-installed wheel hub by removing the two bolts on each side.

Remove any protection part that is placed between the two brake pads.

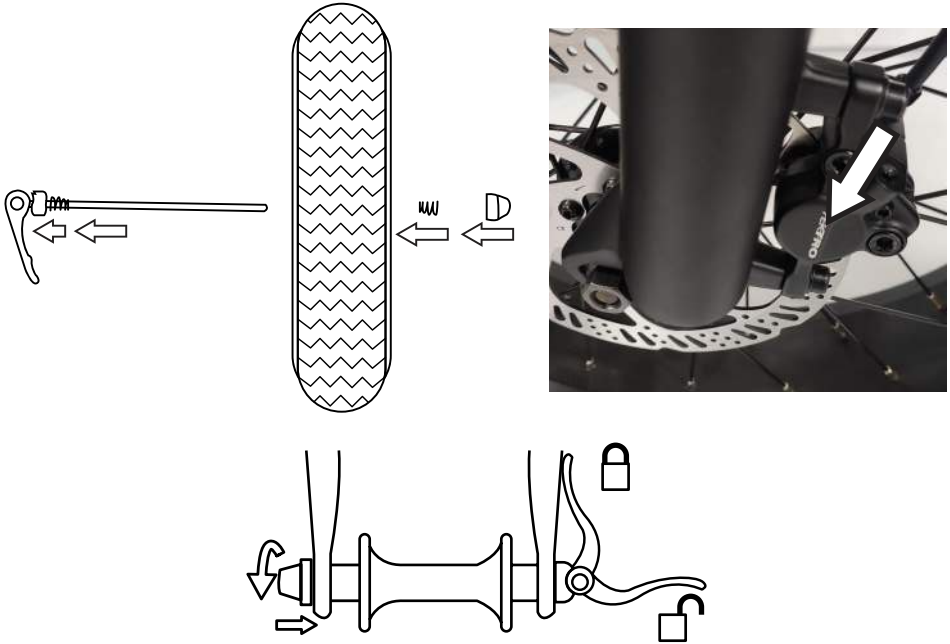

Insert the front wheel into the front fork. Check that the brake disc is placed correctly into the brake calliper.

Do not press the brake levers after the wheel is installed.

Tighten the pre-installed bolts on the wheel. See the section “Recommended torques” for correct tightening of bolts.

Remember to also check the rear wheel, and that all other bolts are secured properly before using the bike for the first time.

Do not use the bike if there is something that is not working correctly during assembly.  
Contact after-sales support.

**WARNING:** Be sure that the wheel is correctly assembled. A loose wheel can lead to injuries or death.

### SEAT ASSEMBLY

Loosen the seat holder. Insert the seat post into the bike and set it to the desired height.  
Lock the seat holder.

**WARNING:** Be careful not to move the seat post over or under the maximum/minimum settings. See seat post markings. |||||

## HANDLEBAR ASSEMBLY

Use the 2 included screws to mount the handlebar. Adjust the handlebar angle to optimal angle before fully tightening the 2 screws. Check that the screws are securely mounted. See the section “Recommended torques” for correct tightening of the screws.

**WARNING:** Secure the handlebar screws correctly before using the bike for the first time.





## PEDAL ASSEMBLY

Each pedal is marked with an “L” for the left pedal and “R” for the right pedal. The illustration to the right shows where the pedals should be mounted.

**Install the left pedal by turning counter-clockwise.  
Install the right pedal by turning it clockwise.**

To secure the pedals, you need to use a wrench on the pedals. See the section “Recommended torques” for correct tightening of the pedals.

**Note: If the pedals do not easily turn during installation, they must be removed again. Do not try to install them by force as this can damage the threads.**

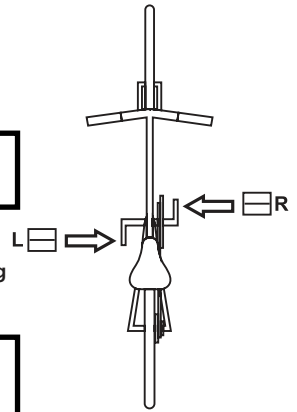

**WARNING:** Tighten the pedals properly before using the bike for the first time.

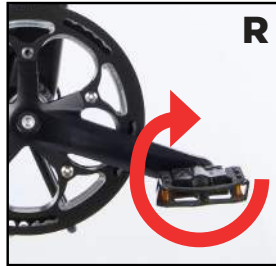
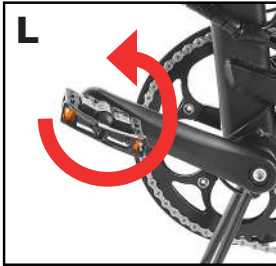

## FRAME FOLDING MECHANISM

If the frame folding mechanism is not tight enough or the safety lock does not click into position, then the folding mechanism needs adjusting.

Open the frame folding lock. Find the big silver screw (shown in the photo on the right). Turn counter-clockwise to tighten the folding lock. Turn clockwise to loosen the folding lock.

## SAFETY LOCK

Open the frame folding lock. Find the little black screw (shown in the photo on the right). Tighten the screw under the frame folding lock.

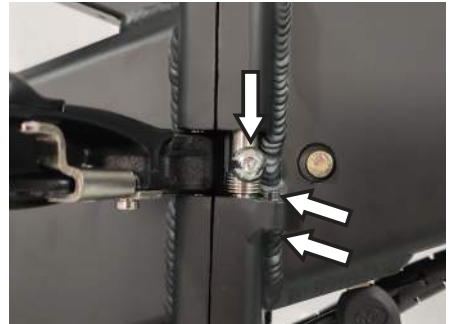

**NOTE:** It is important that the frame folding mechanism is adjusted correctly. If in doubt, contact a bike mechanic or contact after-sales support.

## FOLDING INSTRUCTIONS

### FOLDING THE BIKE

1. Place the crank horizontally with the left pedal in front.



2. Fold the pedals. Push them in and fold them up or down.



3. Loosen the seat holder and push the seat post down to the bottom.



4. Open the quick release of the stem and move it all the way down.



5. Open the frame folding device and fold the bike.

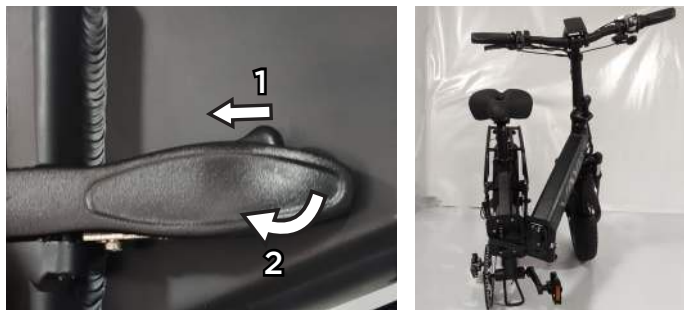

6. Open the folding device of the head tube and fold it down.



### UNFOLDING THE BIKE

1. Raise the head tube and lock it. Remember to also turn the second locking device of the tube lock.



2. Unfold the bike and lock the frame folding device.

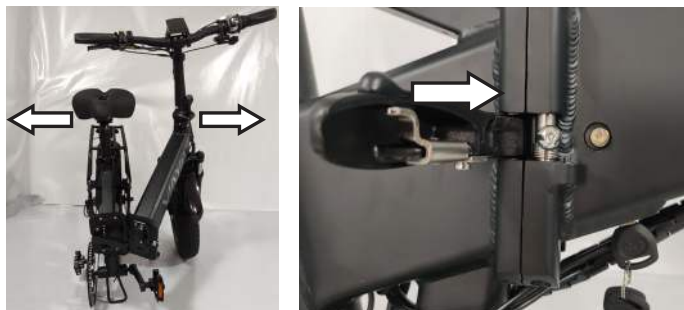

3. Unfold the pedals.

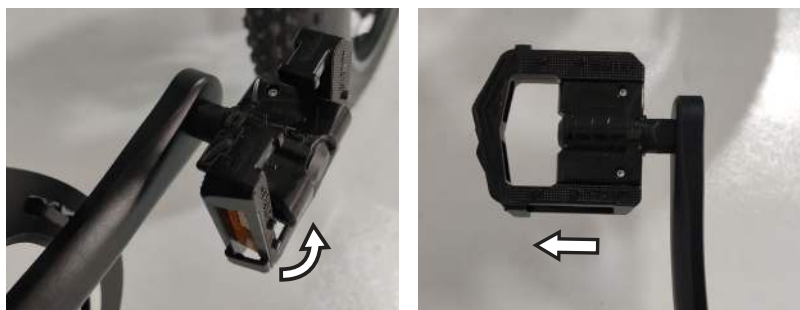

4. Adjust the seat, handlebar, and stem to user preference.



**WARNING:** After unfolding the bike, make sure to check all the safety locks. Please pay extra attention to closing the safety lock of the frame and the head tube to ensure safety.

## LCD DISPLAY



### 1. BATTERY INDICATOR

Shows how much battery capacity is left. Remember to charge the battery when it is low on power. The motor will slowly begin to feel weaker as the battery power indicator goes down.

### 2. MULTIFUNCTION DISPLAY AREA

Shows different settings. Refer to the section OPERATING PRINCIPLES for further information.

### 3. SPEED

Shows the current speed.

### 4. PADDLE ASSIST SYSTEM (PAS)

Shows the PAS gear.



### 5. MOTOR POWER INDICATOR

Shows the current motor power output.

### 6. USB CONNECTION ICON

If the icon is displayed, then the display is connected to a USB device.

## OPERATING PRINCIPLES

- Press and hold the ON / OFF button to power the e-bike on or off.
- Short press the + button to increase the pedal assist gear.
- Short press the - button to decrease the pedal assist gear.
- Press and hold the  button for 2 seconds to turn on/off the front and rear lights. If the  icon is displayed, the lights are turned on. This bike comes with a sensor that will automatically turn on/off the lights when used in daylight or darkness.
- Press and hold the - button to activate the walk assist. It will start after 2 seconds. As soon as you release the - button, the walk assistance is turned off. The  icon is displayed when the walk-assist mode is activated.
- Short pressing the i button will show different display settings:
  - **ODO:** Total accumulated mileage riding the e-bike.
  - **MAX. SPEED:** Maximum achieved speed.
  - **AVG. SPEED:** Average speed while using the bike.
  - **TIME:** Shows how long the e-bike has been turned on.
- Trip is always shown on the display:

- o **TRIP:** Distance driven since you power on the e-bike.
- If not used for 10 minutes, the bike will automatically power off.
- If an error occurs on the electrical system, the  icon with an error code is displayed. See the section “Display error description” for more information.

## SETTINGS

Simultaneously press and hold the + and - buttons for 2 seconds to enter the display settings. Press the i button to enter/confirm settings. Press the + / - buttons to switch between settings or to change settings.

Press and hold the i button for about 1 second to save the selected setting and exit the settings menu.

If not used for 1 minute, the display will automatically exit the settings menu.

## MAIN MENU

Here you select Display settings and advanced settings.

## DISPLAY SETTINGS

- **Trip Reset:** Select YES to reset the trip value; select NO to cancel.
- **Toggle Unit:** Select between Imperial (mil) and Metric (km).
- **Wheel:** Set the wheel size in inches.
- **LCD Luminance:** Set display background brightness level. 0 - 100 %
- **SOC View:** Set battery indicator on display. Select between showing battery indicator in percentages or in volts.
- **AL Sensitivity:** Set the sensitivity of the auto light sensor. Off = turn on/off lights manually.  
1 is low sensitivity and 5 is high sensitivity to daylight/darkness.
- **Dormancy:** If idle the bike will automatically power off after set minutes.
- **Factory reset:** set to yes to reset to default settings.
- **Password:** Here a password can be created. When activated, the password must be entered every time the bike is powered on. See the section “Password”.
- **BACK:** Return to the main menu.

## ADVANCED SETTINGS

- **Power Set :** Set the range of PAS gears to choose from when using the bike and speed for each gear.
- **Set Voltage:** Standard volt setting. Check the battery voltage indicator before changing this setting.
- **Speed Limit:** Set the max motor speed.
- **Current Limit:** Set the current limit. Low for less motor output. This will reduce battery usage and increase the driving range. Increasing the current limit will give more power to the motor but will deplete the battery faster.
- **Assistant Num:** Set the number of magnets in sensor disc.
- **Speed Sensor:** Set the number of magnets in motor.
- **Sensitivity:** Number of magnets in the magnet disc (located at the crank) that need to be passed by the sensor before the motor is activated. At a lower setting, the motor will activate faster.  
**WARNING:** Be aware that if set low, the crank only needs to be turned slightly to activate the motor. The bike is very heavy, and it can result in a dangerous situation if the motor is accidentally activated.
- **Throttle speed:** Set throttle speed.
- **BACK:** Return to the main menu.

## INFORMATION

Soft Ver: current software version.

## PASSWORD

### Setting up the password

Select Password in the menu to set up/change password.



Select Start PassWord and set it to YES to activate the password and set up a password. Input a new password. Press the + / - button to change the value, and then press the i button to confirm input.

To remove the password, select Start PassWord and set it to OFF. Input the current password to confirm the selection.

Select Reset Password to set a new password.

- Input the current password.
- Input a new password.
- Repeat the new password to confirm.

**Note:** If you set a password, write it down. The display cannot be unlocked without the correct password.

## GEAR SHIFTER

1. Change down
2. Change up

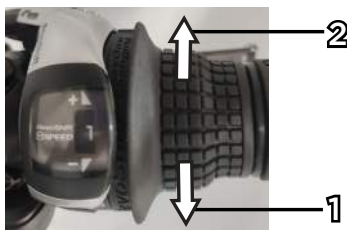

## DRIVING MODES

The e-bike has three driving modes: pedal-assist mode, pedal mode, and walk-assist mode.

### PEDAL-ASSIST MODE

Step on one of the two pedals in any PAS gear, and the motor will start according to your setting to provide you with power output. Once you stop pedalling, the pedal assist will stop automatically.

## PEDAL MODE

Power on the bike and set the PAS gear to 0. The bike will now function as normal but still display information. The bike can also be used with the display powered off.

## WALK-ASSIST MODE

The bike will drive at a speed of 6 km/h. This mode can be used to push the bike up a steep hill or to drive slowly without pedalling.

## BIKES WITH HAND THROTTLE

The hand throttle can be used to drive up to 6 km/h.

## USING THE E-BIKE

Before using the e-bike, you should be aware of several dangers. Please read the following section carefully if you are a beginner or riding the e-bike for the first time.

## SEAT HEIGHT

When seated, adjust the height so your foot can rest on the lowest pedal position. For the optimal cycling position, there should be space to bend your knee slightly.

**WARNING:** Be careful not to move the seat bar over or under the maximum/minimum markings. ||| ||| ||| ||| ||| ||| ||| ||| ||| |||

## SEAT ADJUSTMENT

You can release the bolt under the seat to adjust the seat angle or horizontal position. Remember to tighten the bolt after adjusting the seat. Use two wrenches to tighten the seat, one on each side of the seat.



## STEM HEIGHT

Adjust the stem height to your preferred position.

**WARNING:** Be careful not to move the stem over or under the maximum/minimum markings. See stem markings. ||| ||| ||| ||| ||| ||| ||| ||| ||| |||

## HAND BRAKES

The right hand brake is for braking the rear wheel.  
The left hand brake is for braking the front wheel.

## TIGHTENING OF FASTENERS

Be sure to tighten the adjustment screws, so there is no risk of the seat sliding down, the



stem sliding down, or the handlebar turning or falling off while riding.

**Seat post:** After tightening the screw, press the seat down to check if it is tight enough and attempt to twist the saddle from side to side to ensure it will not move when riding.

**Stem:** After tightening the screw, press the handlebar down to check if it is tight enough.



## **SUSPENSION ADJUSTMENT**

Turn the knob on the left side of the front suspension to adjust the suspension to your weight and driving style.

Turn the knob on the right side of the front suspension to activate/deactivate the suspension.

For other types of suspensions, see included suspensions user manual or go to [www.vayabike.com](http://www.vayabike.com)

## **PRECAUTIONS BEFORE DRIVING**

Check that the components of the e-bike are firmly installed and not damaged.

Check that the brakes work correctly.

Check that the tyres are in good condition and inflated.

Check that the handlebar is securely fastened. If there are loose parts, please tighten them.

Check that all locks are securely tightened, and all secondary locking mechanisms are secured.

**WARNING:** Perform a brake check every time before using the bike. Incorrectly installed, worn, damaged, or dirty brakes can greatly affect the brake distance and result in serious personal injuries and even death.

## **LOCK**



There is a lock located under the frame. It can be turned into 3 different settings. Use the included keys.

**Turn on bike:** Turn the key all the way clockwise. The display can be powered on. The key cannot be removed.

**Remove battery:** Press the key in while turning it counter-clockwise. The battery can now be removed. Remember to take out the key before attempting to remove the battery.

**Lock bike:** Turn the key to the centre position. The bike is now locked and cannot be powered on. The key can be removed.

## **WEIGHT AND SPEED LIMITS**

**WARNING:** Speed and weight limits are set for your safety. Please do not exceed the limits listed in the user manual.

## **WEIGHT RESTRICTIONS**

E-bike maximum total weight: 150 kg

## **OPERATING RANGE**

Please note that the e-bike has a 120 km range with a fully charged battery under ideal conditions. Following are some major factors that will affect the operating range of the bike.

**Terrain:** A smooth flat surface will increase your driving distance, whereas driving uphill or on rough or uneven terrain will reduce your distance significantly.

**Weight:** The weight of the user can affect the driving distance; a lighter user will have a farther range than a heavier user.

**Ambient temperature:** Please ride and store the bike within the recommended temperature range. This will increase the driving distance, battery life, and overall performance of your e-bike.

**Maintenance:** Correct battery charging and maintenance will prolong the battery life.

**Speed and driving style:** Maintaining a moderate speed will increase your distance; while travelling at high speeds for extended periods, frequent starts, stops, idling, along with frequent acceleration and deceleration will reduce your overall distance.

## **BATTERY INFORMATION AND SPECIFICATIONS**

This section is intended to provide you with basic information about your battery and charger. Please read this section carefully to ensure your safety. For user safety and to prolong the life of your battery, as well as to improve battery performance, follow the instructions as stated.

## REMOVING THE BATTERY



Insert the key into the lock and unlock the battery lock. Remove the key.  
Open the frame lock and fold the bike.  
Remove the battery.  
Unfold the bike again.

## INSERTING THE BATTERY

Open the frame folding mechanism and fold the bike.  
Insert the battery with the connectors side last.  
Unfold the bike and lock the frame folding mechanism.  
Insert the key and turn it to lock or turn on bike settings.

## BATTERY SPECIFICATIONS

<b>48 V Battery</b>
Battery: Rechargeable Li-ion battery pack
Model: ZLZCT13S6P175
Charging time: 5 hours
Voltage: 48 Volt
Battery cells: 65 cells
Initial capacity: 17.5 Ah
Operating temperature: -20 to +60 °C
Charging temperature: 0 - 45 °C
Storage time: 2 months
Storage temperature: 15 - 35 °C
Storage humidity: 50 (325) %

The charger and battery supplied must only be used together and are not suitable for other equipment.

## BATTERY STORAGE

Do not charge the battery if the ambient temperature is below 5 °C. The battery needs to be placed in a warmer environment before being charged.

Store the battery inside in a dry place and correct temperature.

Do not store the battery in direct sunlight or in a car. High temperatures can damage the battery and decrease its lifetime.

## CHARGING THE BATTERY



**Step 1:** Turn the key, so the bike is locked in remove battery setting.

**Step 2:** Flick the power switch on the charger to the off position.

**Step 3:** Check that the charging port is clean and dry.

**Step 4:** Connect the charger to the bike's charging port.

**Step 5:** Connect the charger to the mains power.

**Step 6:** Flick the power switch on the charger to the on position.

**Step 7:** The charger indicator light should now turn red to show that the bike is charging. The bike is fully charged when the charger indicator light turns green. The charger automatically stops charging when the charging light turns green.

**Step 8:** Flick the power switch on the charger to the off position. Disconnect the charger from the mains power. Disconnect the charger from the bike.

**Note:** If the charging indicator light does not turn red when the bike is connected for charging, then check that all plugs are properly connected, and the charger power switch is turned to the on position, or check if the battery is already fully charged.

**Note:** The battery can also be removed from the bike for charging. Follow the same steps as above.

## SAFETY TIPS FOR CHARGING

Charge the battery fully before using it for the first time.

To extend the battery life, charge the battery at least every 2 months, and not more than two days after usage. Charge it within the correct temperature range.

Do not charge the battery longer than necessary. Turn off the charger when the battery is fully charged.

Do not store the battery without charging it. Charge the battery at least every 2 months. Only use the supplied charger to charge the battery.

Do not use the charger if the charger or the charger cable is damaged. Contact support for a replacement.

## CHARGER SPECIFICATIONS

<b>Standard charger 48 V</b>
Model number: DPLC165V55-M
Input: 110 - 240 V, 3 A, 50/60 Hz
Output: 54.6.0V == 3.0 A

## INSPECTION, MAINTENANCE, AND STORAGE

Your e-bike requires routine inspection and maintenance. This chapter describes maintenance steps and important operating tips. Before you perform the following operations, ensure the power and charging cable is disconnected.

The bicycle (e.g. non-electrical) parts of the e-bike are standard components that can be obtained from your local bike shop. Ensure that replacement parts are genuine parts. Contact customer support if in doubt.

Use of non-genuine or non-compatible parts, or modification of the bicycle outside its specifications is considered tampering. Tampering may result in increased risks to the user, and the user bears responsibility for any resulting issues.

### INSPECTING YOUR E-BIKE

Routinely check the frame and tyres of the e-bike for damage or excessive wear and for correct tyre pressure, check all bolts and screws and tighten them if needed.

Check that the handlebar screws are secure. Check that the handlebar cannot be moved up and down.

Check the side of the front and rear wheels for correct tyre pressure. See markings on tyres for correct tyre pressure.

The rims are subject to wear, which must be checked to ensure safety.

Check the brake pads for wear. If they are worn (approx. 1 mm left), replace the brake pads immediately.

See service folder for more information.

See the photo below, where screws must be checked and secured after each ride.



## CLEANING YOUR E-BIKE

Disconnect the charger and turn your e-bike off. Remove the battery. Use a moist cloth to clean the e-bike. Do not use oil on the brakes. Clean the brakes using a cloth dipped in isopropyl alcohol. Do not use a high-pressure cleaner. Cleaning under running water is not recommended. Do not spray water on the electrical components. After cleaning, make sure to test the brakes before using the e-bike again.

## CHAIN MAINTENANCE

Clean and lubricate the chain and chainrings regularly to extend their lifetime. Clean no less than once a month with daily use, more in poor conditions or if the chain becomes noticeably dirty.

Regularly clean the chain with a suitable chain cleaner.

Clean the chainrings using a neutral cleaning agent.

Use suitable lubrication on the chain and chainrings.

## STORING YOUR E-BIKE

If the ambient temperature of the storage location is below 0 °C, please do not charge. Bring the battery into a warmer environment before charging. Check under the section “Battery information and specifications” for more details.

To prevent dust from getting into your e-bike and battery, try wrapping or sealing it with its original packaging materials.

Store your e-bike indoors. If the bike is wet, dry it before storage.

Store your battery indoors in a dry place and suitable temperature range.

Do not store the battery in direct sunlight or in a car. High temperatures can cause damage and decrease the life of the battery.

## ADJUSTING THE REAR DERAILLEUR

Step 1:

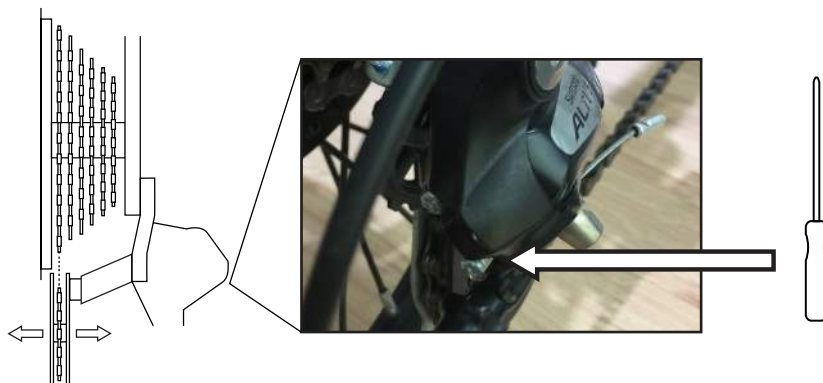

When lifting the rear of the bike and turning the pedals by hand, use the gear change to select the lowest gear.

Use a suitable screwdriver to turn the screw marked “L” (low gear) to adjust the rear derailleur until it is vertically aligned below the lowest gear. See the photo above.

**Step 2:**

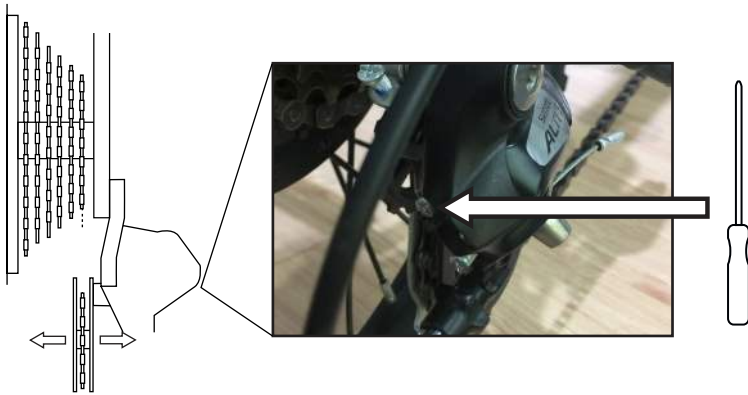

When lifting the rear of the bike and turning the pedals by hand, use the gear change to select the highest gear.

Use a suitable screwdriver to turn the screw marked “H” (high gear) to adjust the rear derailleur until it is vertically aligned below the highest gear. See the photo above.

**Step 3:**

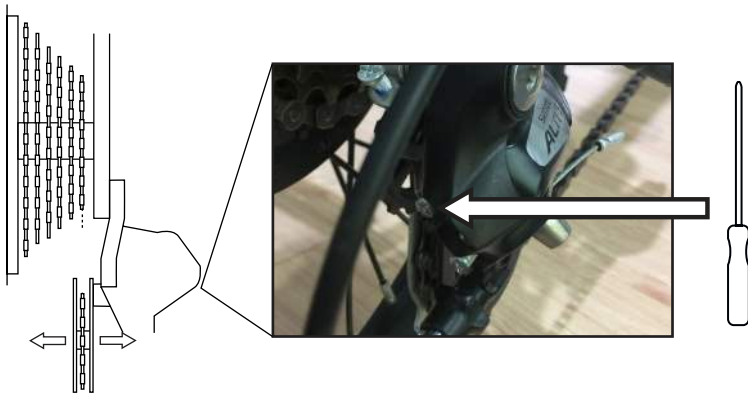

When lifting the rear of the bike and turning the pedals by hand, use the gear change to change the highest to the lowest gear one at a time. If the derailleur is adjusted correctly, the gears should shift quickly without any grinding noise.

If there are still problems after you adjust the rear derailleur, you can fine-tune it.

Rotate the adjuster (C) clockwise if there is a problem going from the lowest to the highest gear.

Rotate the adjuster (C) counter-clockwise if there is a problem going from the highest to the lowest gear.

Turn the adjuster about a quarter turn at a time and then change the gears to see if the problem is fixed. Repeat step 3 if the problem persists.

## **HYDRAULIC BRAKES**

The brake pads are worn over time. The hydraulic brake will auto-adjust to compensate as the brake pads are wearing down.

## **NOISE FROM BRAKES**

- The brake disc needs cleaning.
- You need to clean or sand the brake pads to remove impurities.
- The brake pads are worn and must be replaced.

## **THE BRAKES ARE NOT WORKING**

- The bike has been turned upside down. Solve this by placing the bike down on both wheels. Press the brake levers several times until the brakes work again normally.
- The brake system has lost fluid, or air has entered the brake system. We recommend taking your bike to a bike repair shop. At own risk there are guides and equipment to repair at home.

## **INSPECTING THE TRUENESS OF THE WHEELS**

Over the lifetime of the bike, the wheels may begin to run out of true.

To check the trueness of a wheel, lift the e-bike and spin the wheel. If the wheel wobbles from side to side, then the wheel is out of true and will need repairing.

Special tools are required for repair. We recommend that the wheels be trued by a qualified repair technician. Contact your local retailer for more information on wheel repairs.

## **INSPECTING THE WHEEL BEARINGS**

Over the lifetime of the bike, the wheel bearings may become worn and will need servicing. To check, grab the tyre of either the front or rear wheel while holding the bike securely.

Vigorously move the tyre from side to side. If the wheel moves at the wheel hub (the centre of the wheel), the bearing may be worn.

Special tools are required for repair. We recommend that the bearings be replaced by a qualified repair technician. Contact your local retailer for more information on wheel repairs.

## **REMOVING A WHEEL**

Release the wheel bolts on each side of the wheel.

**Note:** Pay attention to the position of the washers when you remove them.

Mount the wheel and washers in the same order and orientation as you remove them.



## CHANGING AN INNER TUBE

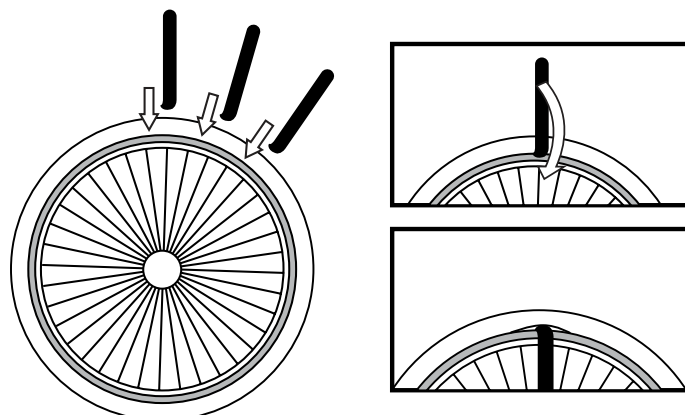

If you have a puncture, you will need to remove and patch or replace the inner tube.

**Note:** A set of tyre levers is needed to remove the inner tube. This is not included in the box.

Remove the dust cap from the tube valve. Deflate the tyre fully.

Push both sides of the tyre towards the centre, away from the rim, to loosen the tyre.

Insert a tyre lever anywhere between the tyre and the rim but not close to the tube valve.

Insert the second tyre lever close to the first one and press it down on the tyre lever.

Continue this process all around until you can remove the tyre.

After the tyre is removed, carefully remove the inner tube, starting with the valve.

Check the inner surface of the tyre for signs of damage or foreign matter.

After the tube has been repaired, partially inflate the inner tube using a bicycle pump.

Carefully feed the inner tube into the tyre, starting with the valve. The valve must be aligned with the hole in the rim.

Replace the tyre in the rim, one small section at a time. For the last part, use the tyre levers to refit the last section.

## REPLACING THE BRAKE PADS

See our webpage on how to replace brake pads:

[www.vayabike.com](http://www.vayabike.com)

## E-BIKE SPECIFICATIONS

Net weight: 30 kg

Max load: 150 kg

Size (folded): 103 x 59 x 78 cm

Size (unfolded): 180 x 65 x 78 cm

Wheel size: 20 x 4 inch

Max compatible wheel size: 20 x 4 inch

Protection rating: IP54

Number of bike gears: 8

Number of assist mode gears: 5

Max pedal assist speed: 0 - 25 km/h

Operating range: Up to 120 km



## RECOMMENDED TORQUES

<b>PART</b>	<b>TORQUE (NM)</b>
Front wheel bolt	28 - 32 Nm
Rear wheel bolt	30 - 35 Nm
Handlebar clamps	5 - 8 Nm
Adjusting nuts	12 - 15 Nm
Seat bolts	16 - 18 Nm
Brake cable bolt	12 - 15 Nm
Brake mounting bolt	12 - 15 Nm
Seat post nuts	16 - 18 Nm
Crank	35 - 40 Nm
Folding handle	6 - 8 Nm
Flange mounting screw	3 - 5 Nm
Rear derailleur	6 - 9 Nm
Sprocket holder screw	35 - 40 Nm
Gear change holder screw M5	5 - 7 Nm
Brake disc screw M5	20 - 22 Nm
Brake cable bolt	20 Nm
Support base	5 - 7 Nm
Battery connecting screw	5 - 7 Nm
Handbrake	5 - 8 Nm

## DISPLAY ERROR MESSAGE

If an error occurs in the electrical system, the display will show an error code.

<b>CODE</b>	<b>FAULT</b>
21	Power failure
22	Hand throttle fault
23	Motor fault
24	Motor fault
25	Brake fault
30	Communication fault



Declaration of Conformity: (See provided document).  
Products marked with this symbol comply with all applicable community regulations of the European Economic Area

## DISPOSAL



Electrical and electronic equipment (EEE) contain materials, parts and substances, which can be dangerous to the environment and harmful to human health if waste of electrical and electronic equipment (WEEE) are not disposed of correctly.

Electrical and electronic equipment, which are marked with the WEEE logo (as shown on the left), should not be thrown away with your household waste. Contact your Local Authority Waste Disposal Department, as they will be able to provide details of the recycling options available in your area.



This symbol on the battery or on the packaging indicates that the battery provided with this product shall not be treated as household waste. The recycling of the materials will help to conserve natural resources. Contact your Local Authority Waste Disposal Department, as they will be able to provide details of the recycling options available in your area.

Imported by:  
Vaya Nordic ApS, Pioner Alle 16D, 9200 Aalborg SV, Denmark.  
Date of issue: 03/2023  
Version: PO-1697



## E-BIKE

In the event of a malfunction, please contact our customer service here:

### ELCARE SWEDEN



Låsblecksgatan 7  
58941 Linköping, SE



DK: +46855121787  
SE: +46855121787  
NO: +46855121787  
FI: +35894245515



service.vaya@elcare.com

For further information and updates visit [www.vayabike.com](http://www.vayabike.com)

**Warning:** Does not cover improper use of the product or failure to follow the warnings and operating instructions in this instruction manual. There is also limited coverage on wearing parts such as wheels, battery, brakes and grips. These parts are considered wear parts and can subsequently be ordered at [www.vayabike.com](http://www.vayabike.com)