



# VAYA



# MINI E-BIKE

---

USER GUIDE  
PO-1697



## CONTENTS

WELCOME.....	4
GENERAL .....	4
SYMBOL EXPLANATION.....	4
BEFORE YOU START .....	4
IMPORTANT SAFETY INFORMATION .....	5
BOX CONTENT .....	7
FOLDING INSTRUCTIONS .....	7
FOLDING THE BIKE .....	7
UNFOLDING THE BIKE.....	10
LCD DISPLAY .....	12
OPERATION PRINCIPLES .....	12
SETTINGS .....	12
GEAR SHIFTER .....	13
PEDAL ASSIST MODE .....	13
USING THE E-BIKE.....	13
SETUP .....	14
SEAT HEIGHT.....	14
SEAT ADJUSTMENT .....	14
STEM HEIGHT .....	14
HAND BRAKES.....	14
TIGHTENING OF FASTENERS.....	14
PRECAUTIONS BEFORE DRIVING.....	15
WEIGHT AND SPEED LIMITATIONS .....	15
WEIGHT RESTRICTIONS .....	15
OPERATING RANGE.....	15
BATTERY INFORMATION AND SPECIFICATIONS .....	16
LOCK/UNLOCK BATTERY .....	16
BATTERY ON/OFF BUTTON .....	16
BATTERY POWER.....	16
BATTERY SPECIFICATIONS.....	16
CHARGER SPECIFICATIONS.....	17
CHARGING YOUR E-BIKE .....	17
SAFETY TIPS FOR CHARGING .....	17
CARRIER INFORMATION .....	17
CARRIER SPECIFICATIONS.....	17
INSPECTION, MAINTENANCE, AND STORAGE.....	17
INSPECTING YOUR E-BIKE.....	18
CLEANING YOUR E-BIKE .....	18
CHAIN MAINTENANCE.....	18
STORING YOUR E-BIKE.....	18
ADJUSTING THE REAR DERAILLEUR .....	19
ADJUSTING THE V-BRAKE CABLE TENSION .....	20
FINE-TUNING THE CABLE TENSION .....	21
ADJUSTING THE V-BRAKE SPRING TENSION.....	21
INSPECTING WHEEL TRUENESS .....	21
INSPECTING RIM WEAR.....	22
INSPECTING THE WHEEL BEARINGS .....	22
REMOVING THE WHEELS .....	22
V-BRAKE QUICK RELEASE.....	22
CHANGING AN INNER TUBE.....	23
REPLACING BRAKE PADS.....	23
E-BIKE SPECIFICATIONS.....	24
RECOMMENDED TIGHTENING INFORMATION.....	24
DISPLAY ERRORS.....	24
DISPOSAL .....	25

# WELCOME

## GENERAL

READ CAREFULLY BEFORE USE.

## SYMBOL EXPLANATION

The A-weight emission sound pressure level at the driver ears is less than 70dB(A).



For indoor use only



This unit is double insulated



Wear personal protective equipment



Read manual before operating the product



Class III protection against electric shock.



The center (tip) of the output plug is positive (+) and the barrel of the output plug is negative (-).



For safe and proper use, follow these instructions.  
Keep this user manual for future reference.

## BEFORE YOU START

Before you use the E-Bike for the first time, please read the USER MANUAL thoroughly and follow the instructions and warnings to ensure your own safety and the safety of others.

It is recommended to keep the instruction manual for future reference.

**For further information and updates, visit [www.vayabike.com](http://www.vayabike.com).**

## **WARNING**

The E-Bike is designed for city and trekking, so use the bike on roads and smooth paths only. Using the bike on other surfaces or in other ways can result in damage and loss of control that can lead to serious personal injuries or death.

Failure to follow the basic instructions and safety precautions listed in the USER MANUAL can lead to damage to your E-Bike, damage to other property, serious bodily injury, and even death.

As with all mechanical components, E-Bikes are subject to wear and high stress. Different materials and components may react to wear or stress in different ways. If the design life of a component has been exceeded, it may suddenly fail, possibly causing injury to the rider. Any form of cracks, scratches, or discolouration in highly stressed areas indicates that the life of the component has been reached and that it should be replaced.

## **IMPORTANT SAFETY INFORMATION**

### **WARNING - DANGER**

1. Children should be supervised to ensure that they do not play with the E-Bike. Cleaning and user maintenance should not be done by children.
2. The battery charger may be used by children aged 8 years and above and persons with reduced physical, sensory or mental capabilities or lack of experience and knowledge provided that they have been given supervision or instruction regarding the use of the device in a safe way and provided they understand the hazards involved.
3. Do not attempt to modify, change, or open the battery.
4. Do not place the battery near any heat sources such as heaters. The battery must not be heated or exposed to open flames.
5. Do not subject the battery to heavy impact or throw it.
6. Do not submerge the battery in water or let the battery connector become wet.
7. Only use the charger included in the box. The E-Bike must only be supplied with safety extra low voltage corresponding to the marking on its battery.
8. Do not exceed the maximum weight limit (100 kg)

## **WARNING**

1. Do not insert the battery if the battery connector on the E-Bike is wet. Place the E-Bike inside and make sure that the connector on the E-Bike is completely dry before inserting the battery.
2. Do not leave the battery in direct sunlight. Do not leave the battery in a vehicle during high temperatures or in other warm locations. This can cause battery leakage.
3. Do not charge the battery outside or in areas with high air humidity.
4. Do not use the battery if there is any visible damage on it.
5. Ensure that the wheels are mounted correctly before riding the bike.
6. Learn how to ride and use all functions of the E-Bike before using it in traffic.
7. Check that the front light works before riding the E-bike in darkness.
8. Always remove the battery before performing any maintenance or installation work on the E-bike.
9. If the charger supply cord is damaged, it must be scrapped, and the charger must be replaced by the manufacturer or its service agent – please contact the service number.
10. The included charger is only to be used with this E-Bike and not with any other electronic device. Do not use the charger to charge any non-rechargeable batteries.
11. The luggage carrier is not suitable for the attachment of a child seat.
12. Do not abuse your E-Bike, as doing so can damage your unit and cause failure to the operating system which can lead to injury.
13. Do not ride the E-Bike while wearing loose or torn clothing.
14. Safety-critical components should be replaced with genuine replacement parts.

15. Please be aware of the specific risk of entrapment during normal use and maintenance on the front/rear wheel, chain, and sprocket.
16. Do not modify or change the luggage carrier.
17. Be aware of an increased braking distance and difference in steering when the luggage carrier is loaded.
18. Make sure that any luggage fitted to the luggage carrier is securely fitted in accordance with the instructions of this manual and that there are no loose straps that can get caught in the wheel.

## **CAUTION**

1. Please wear all appropriate safety and protective gear while using the E-Bike. See the operating principles section for more information.
2. Do not use the E-Bike while under the influence of drugs and/or alcohol.
3. Brakes can get hot after use: do not touch them after braking.
4. If the handlebar grips become damaged and expose the metal ends of the handlebar, these must be capped using internally fitted "bar end plugs".
5. Do not ride the bike in extreme weather such as heavy snow, rain, hail, sleet, on icy surfaces, or in extreme heat.
6. The depth of wading should not exceed 80 mm.
7. Do not immerse the bike in water.
8. Do not ride the bike up and down steps.
9. Do not use the E-Bike while talking, texting, or looking at your phone.
10. At high speeds, always take into consideration longer stopping distances.
11. Please note possible increased braking distance in wet weather.
12. Do not clean your bike with pressure washers. High-pressure cleaning may remove lubricant and/or grease from bike parts.
13. When lubricating the moving parts of the E-Bike, take care not to get any lubricant on the rims of the wheels or the brake pads.

## **NOTE**

1. Always use the battery plug to protect the charging port when not in use.
2. Users who disassemble the E-Bike forfeit their right of warranty.
3. **PAY ATTENTION** – Look at where you are riding and be aware of the surface conditions, people, places, property, and objects around you.
4. When using the E-Bike in the dark, be sure to follow the laws regarding rear and front lights and correct reflectors. The supplied light is for additional lighting only.
5. Do not ride the E-Bike where it is not permitted. Check the limitations of use according to local road safety regulations.
6. These instructions are available from the service address at the base of the page.

These instructions must be read and understood by each rider before use. Retain them for future reference and pass them on to any new owner or rider of the E-bike. It is recommended to keep the original box in the unlikely event that you need to return the product to us or send it in for repair.

## **WARNING**

The warranty does not cover improper use of the product or the failure of users to follow the warnings and operation instructions in this user guide. There is also a limited warranty on wearable parts such as tires, battery, motor, chain, cassette, brakes, and handles. These parts are considered wearable parts and can be ordered at [www.vayabike.com](http://www.vayabike.com). See the service folder for more information.

## BOX CONTENT



E-Bike

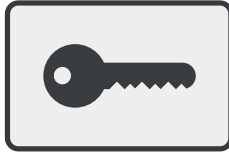

Key x 2



Tool bag

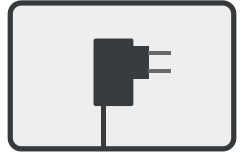

Power adaptor

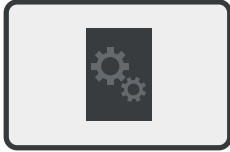

Manual

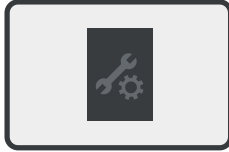

Service folder

## FOLDING INSTRUCTIONS

### Folding the Bike

1. Place the crank horizontally with the left crank in front.



2. Fold the pedals. Push them in and fold them up or down.

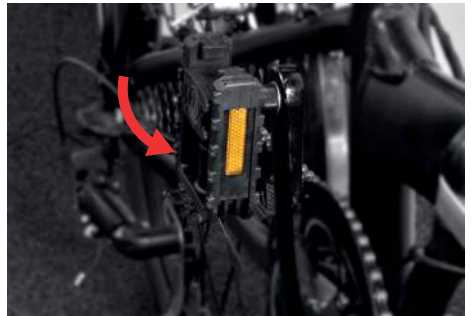

3. Loosen the seat holder and push the seat post down to the bottom. Then lock it tightly. When unfolded, the E-Bike will rest on the end of the seat post.



4. Open the quick release of the stem and move it all the way down.



5. Open the quick release of the handlebar and turn it so the hand brake is facing downward. Lock the handlebar quick release.

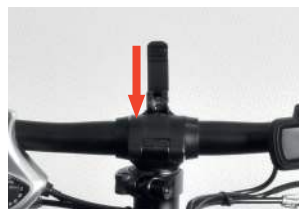



6. Open the folding device of the frame and fold the bike partially.

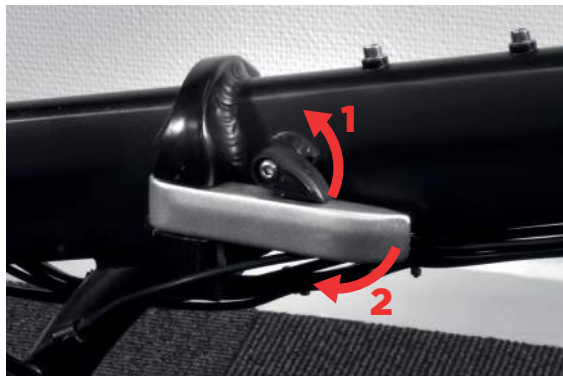

7. Open the folding device of the head tube and fold it down.

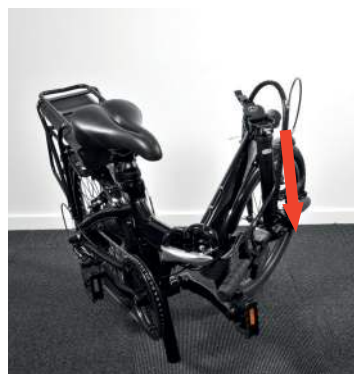

8. Fully fold the device.



**NOTE:** When folding the bike always remember to push the seat bar down to the bottom so the bike is resting on the end of the seat post and not on the crankset.



## Unfolding the Bike

1. Move the two wheels slightly away from each other.



2. Raise the front tube and lock it (1). Remember also to turn the second locking device of the tube lock (2).

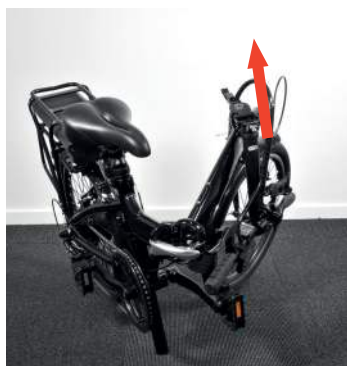

3. Unfold the device and lock the folding device of the frame (1). Remember also to lock the second locking device of the frame folding lock (2).

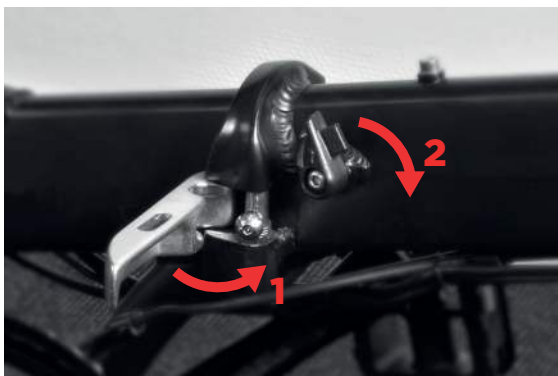

4. Unfold the pedals.

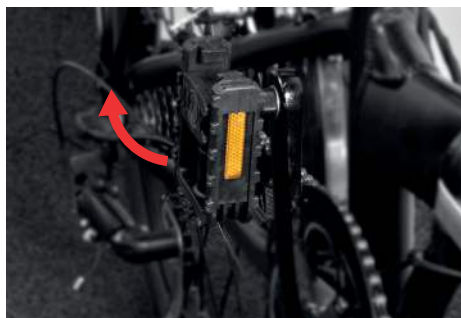

5. Adjust the seat, handlebar, and stem to the user's preference.

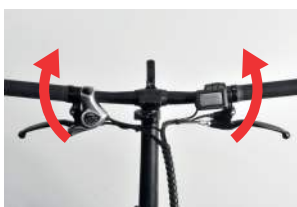

**WARNING:** After unfolding the bike, make sure to check all the safety buckles. Please pay extra attention to closing the safety buckle of the frame and the head tube to ensure safety.

## LCD DISPLAY



### 1. BATTERY INDICATOR

Displays an estimate of the remaining battery.

A fully charged battery (100%) will show 5 bars. Please remember to charge your battery when it is on its last bar. As the battery depletes, the strength of the motor will get weaker.

### 2. MULTIFUNCTIONAL DISPLAY AREA

Displays different settings. Refer to the OPERATION section for further information.

### 3. SPEED

Shows the current speed.

### 4. POWER GEAR ADJUSTMENT

Shows the pedal-assistance gear. Goes from 0-5.

### 5. Shows that the headlight is turned on.

### 6. STATUS DISPLAY AREA

Provides information of various bike statuses.

 Motor failure. For problems with the motor, contact after-sales support.

## OPERATION PRINCIPLES

- Press and hold the ON / OFF button to power on or off the E-Bike.
- Press the + button to increase the pedal assistance gear.
- Press the - button to decrease the pedal assistance gear.
- Press and hold the + button for 2 seconds to turn on the front light.
- Press the ON / OFF button to show different display settings:
  - o ODO: Total accumulated mileage riding the E-Bike.
  - o TRIP: Distance driven since powering on the E-Bike.
  - o VOL: The current battery voltage.
  - o Time: How long the E-Bike has been turned on.

## SETTINGS

Hold the + and - buttons down simultaneously for 2 seconds to enter or exit/save the settings menu.

Press the ON / OFF button to go to next setting. Press the + / - buttons to change settings.

- P01: Display backlight brightness. Range from 1-3. 3 is highest setting.
- P02: Speed display settings. 0 is kilometres. 1 is miles.
- P03: No function.
- P04: Display dormancy time: 1-60 dormancy time in minutes. 0 is no dormancy.

- P05: No function.
- P06: Wheel diameter: enter wheel diameter in inches. This information is related to the display values and needs to be set correctly for accurate measurements. Default setting is 20. If changed, the values on the display will not be accurate.
- P07: No Function.
- P08: Max assist speed. Set to 25 km/h.
- P09: No function.
- P10: No function.
- P11: Help sensitivity setting. Range: 1-24. The lower the number, the more power the pedal assistance will give. The lowest setting is recommended for people who need extra help from the motor.
- P12: Help start intensity setting. Range 0-5. How quickly the E-Bike goes up to max assisted speed. Select 5 for max assistance acceleration.
- P13: Number of magnets in the speed sensor. Changing this value can affect the normal operation of the bike. Default setting is 12.
- P14: No function.
- P15: No function.
- P16: Reset mileage date. When in this setting, press and hold the + button for 5 seconds to reset.
- P17: No function.
- P18: No function.
- P19: No function.
- P20: No function.

## GEAR SHIFTER

1. Decrease gear
2. Increase gear

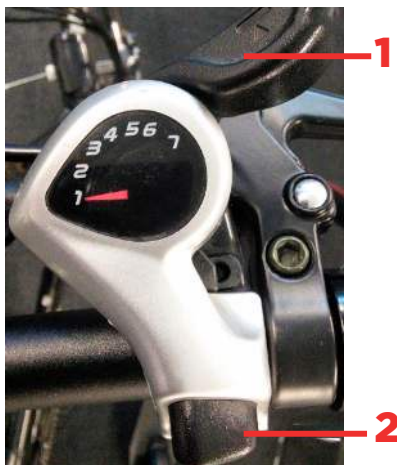

## Pedal Assist Mode

Step on one of the two pedals in any gear of the booster. The motor will start under the action of the inductor to provide you with the power output. Once you stop pedalling, the pedal assistance will stop automatically.

## USING THE E-BIKE

Before using the E-Bike, there are several dangers you should be aware of. Please read the following section carefully if you are a beginner or riding the E-Bike for the first time.

## PLEASE READ THE FOLLOWING INSTRUCTIONS CAREFULLY

Step 1: Getting started - Take your E-Bike out of the box.

Step 2: Charge the battery - Make sure the battery is fully charged before you use the E-Bike for the first time. For charging instructions, please follow the battery information and charging specifications.

Step 3: Wear a safety helmet and protective gear to avoid possible injury.

### Setup

Unfold the E-Bike. See the “Unfolding the E-Bike” section.

### Seat Height

When seated, adjust the height so your foot can rest on the lowest pedal position. In the optimal cycling position, there should be space to bend your knee slightly.

**WARNING:** Be careful not to move the seat bar over or under the max/minimum settings. See seat bar markings. ||| ||| ||| ||| ||| ||| ||| ||| ||| |||

### Seat Adjustment

You can release the bolt under the seat to adjust the seat angle or horizontal position. Remember to tighten the bolt after adjusting the seat. Use two wrenches to tighten the seat, one on each side of the seat.



### Stem Height

Adjust the stem height to your preferred position.

**WARNING:** Be careful not to move the stem bar over or under the max/minimum settings. See stem bar markings. ||| ||| ||| ||| ||| ||| ||| ||| ||| |||

### Hand Brakes

The right handle brake is for braking the rear wheel.

The left handle brake is for braking the front wheel.

### Tightening of Fasteners

Be sure to tighten the fastener adjustment screws so there is no risk of the seat falling down, the front stem falling down, or the handle bar turning up/down while riding.

Seat post: After tightening the fastener screw, put downward pressure on the seat to check if it is tight enough and attempt to twist the saddle from side to side to ensure it will not move when riding.

**Front stem:** After tightening the fastener screw, put downward pressure on the steering wheel to check if it is tight enough.

**Handle bar:** After tightening the fastener screw, try twisting the handlebar forward and backward to ensure it will not move when riding.



### **Precautions before Driving**

Check that the components of the E-Bike are firmly installed and free from damage.

Check that the brakes work correctly.

Check that the tires are in good condition and inflated.

Check that the handlebar is securely fastened. If there are signs of the handlebar loosening, tighten it.

Check that all locks are securely tightened, and all secondary locking mechanisms are secured.

**WARNING:** Perform a brake check every time before using the bike. Incorrectly installed, worn, damaged, or dirty brakes can greatly affect the brake distance and result in serious personal injuries, and even death.

### **WEIGHT AND SPEED LIMITATIONS**

**WARNING:** Speed and weight limits have been set for your own safety. Please do not exceed the limits outlined in the user manual.

#### **Weight Restrictions**

E-Bike maximum total weight: 100 kg

Luggage carrier max weight: 10 kg

### **OPERATING RANGE**

Please note that the E-Bike has a 50 km range with a fully charged battery under ideal conditions. The following are some of the major factors that will affect the operating range of the bike.

**TERRAIN:** A smooth flat surface will increase your driving distance, whereas driving uphill or on rough or uneven terrain will reduce your distance significantly.

**WEIGHT:** The weight of the user can affect the driving distance. Lighter users will have a farther range than heavier users.

**AMBIENT TEMPERATURE:** Please ride and store the bike within the recommended temperature range. This will increase the driving distance, battery life, and overall performance of the E-Bike.

**MAINTENANCE:** Proper battery charging and maintenance will prolong battery life.

**SPEED AND DRIVING STYLE:** Maintaining a moderate speed will increase your distance, while traveling at high speeds for extended periods, frequent starts, stops, idling, and frequent acceleration and deceleration will reduce your overall distance.

## **BATTERY INFORMATION AND SPECIFICATIONS**

This section is intended to provide you with basic information about your battery and charger. Please read this section carefully to ensure your safety. For user safety, prolonged battery life, and improved battery performance, follow the instructions as stated.

### **Lock/Unlock Battery**

You can lock the battery to the E-Bike by inserting the provided key and turning it clockwise. If you need to unlock the battery to remove it from the E-Bike, insert the key and turn it anticlockwise.

It is recommended to always lock the battery during use.

When the battery is removed, you can hold down the indicator button on the battery to display an estimate of the remaining battery power.



### **Battery ON/OFF Button**

To use the battery, set the button on the side of the battery to on “-“.

You can turn the battery off by setting the button to “o” when not in use. You can still use the battery indicator button when the battery is off.

### **Battery Power**

When the battery indicator shows low battery capacity, please charge the battery for 2-3 hours using the charger that you received in the E-Bike package. To fully recharge the battery, follow the instructions under “Charging your E-Bike”.

### **Battery Specifications**

Battery: Rechargeable Li-ion Battery Pack

Model: CP1178WC

Charging time: 3-4 hours

Voltage: 36 Volts

Battery cells: 30 cells

Initial capacity: 6.6 Ah

Operating temperature: -15 - 55 °C

Charging temperature: 0 - 55 °C

Storage time: 6 months

Storage temperature: 0 - 25 °C

Storage Humidity: 60 (+/- 25%) %

The supplied charger and battery must only be used together and are not suitable for other devices.



## Charger Specifications

Model number: CP4220

Input: 100-240V, 3A, 50/60Hz

Output: 42.0V = 2.0A

## Charging Your E-Bike

Step 1: Ensure that the charging port is clean and dry.

Step 2: Plug the charger into the power outlet and connect the cable with the power supply. Make sure the light on the charger is lit GREEN.

Step 3: Connect the charging cable to the charging port of the E-Bike battery. The indicator light on the charger should change to RED, indicating that the battery is now being charged. When the red light on the charger turns GREEN, this indicates that the battery is fully charged. A full charge typically takes 2-3 hours. The charger will automatically stop charging when the light is GREEN.

Step 4: Unplug the charger from the battery and the power outlet.

Step 5: Attach the charging port cover to protect the charging port.

**NOTE:** If the GREEN light on the charger does not turn RED when you plug it into the battery, check that all the connections are proper or that the battery is not already fully charged.

## Safety Tips for Charging

Charge the battery for at least 5 hours before first use.

To maximise battery life, please charge every other month when not in use and two days after driving. Please charge the battery at the suitable temperature.

Do not store the battery without charging it. Charge the battery at least once every 2 months.

Only use the charger that was included in the box to charge the battery.

If any damage occurs to the charger or cable, stop using the charger and contact after-sales support to obtain a replacement.

## Carrier Information

**WARNING:** Only carry luggage in the luggage carrier when riding the E-Bike.

The luggage carrier is not designed to pull a trailer.

When carrying luggage using the carrier, be aware of any reflectors or light that the luggage may block.

Distribute luggage evenly between the two sides of the luggage carrier.

If using straps to secure the luggage, make sure that none of the straps are loose to ensure they don't get caught in the wheel.

## Carrier Specifications

Carrier max weight: 10 kg

Battery max weight: 2.3 kg

Max compatible wheel size and tyre for the carrier: 20 x 1.75 inches

## INSPECTION, MAINTENANCE, AND STORAGE

The E-Bike requires routine inspection and maintenance. This chapter outlines maintenance steps and important operating tips. Before you perform the following operations, ensure the power and charging cable are disconnected.

The bicycle (e.g. non-electrical) parts of the E-Bike are standard components that can be obtained from your local bike shop. Ensure any replacements purchased are exact replacements. Contact customer support if in doubt. Use of non-original or non-compatible parts, or modification of the bicycle outside the specification in which it was

delivered is considered tampering. Tampering may result in increased risks to the user. The user bears responsibility for any issues resulting from tampering.

### **Inspecting Your E-Bike**

Routinely check the body and tyres of the E-Bike for damage, excessive wear, and correct air pressure. Check all bolts and screws, and tighten if needed.

Check the side of the front and rear wheels for correct tyre pressure.

The fasteners of the luggage carrier are to be secured and checked frequently.

The rims are subject to wear which must be checked to ensure they are intact.

Check the brake pads for wear. If the brake pads are worn out, replace them immediately.

See the photo below for which screws to check and secure after each ride.



### **Cleaning Your E-Bike**

Disconnect the charger and turn off the E-Bike. Remove the battery.

Use a moist cloth to clean the E-Bike. Do not use oil on the brakes.

Do not use a high-pressure jet. Cleaning under running water is not recommended.

After cleaning the E-Bike, make sure to test all the brakes before using the E-Bike again.

### **Chain Maintenance**

Clean and lubricate the chain and chainrings regularly to extend their lifecycle. Clean no less than once a month with daily use, and more regularly in poor conditions or if the chain becomes noticeably dirty.

Regularly clean the chain with a suitable chain cleaner.

Clean the chainrings using a neutral cleaning detergent.

Use suitable lubrication on the chain and chainrings.

### **Storing Your E-Bike**

If you are storing the E-Bike for an extended period of time, please fully charge the battery at least once every two months.

If the ambient temperature of the storage location is below 0°, please do not charge the

E-Bike. You must bring the battery into a warmer environment before charging. Check the Battery Information and Specifications sections for more details.

To prevent dust from getting into your E-Bike and battery, try wrapping it or sealing it with its original packaging.

Store the E-Bike indoors. If wet, dry the E-Bike before storage.

Store the battery indoors and in a dry and suitable temperature range.

Do not store the battery in direct sunlight or in a car. Overly high temperatures can cause damage to the function and lifecycle of the battery.

## Adjusting the Rear Derailleur

Step 1:

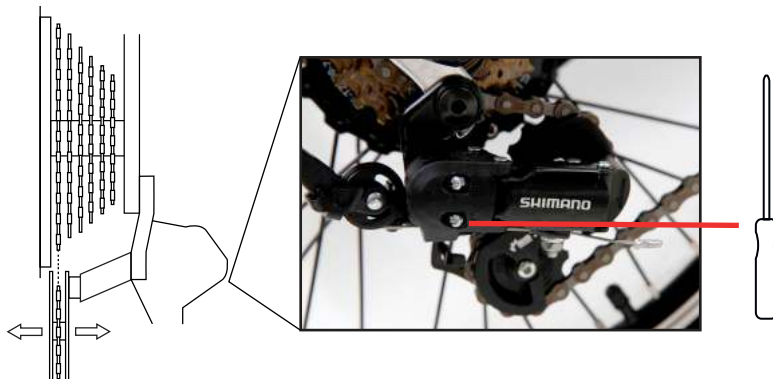

While lifting the rear of the bike and turning the pedals by hand, use the gear shifter to select the lowest gear.

Use a suitable screwdriver to turn the screw marked with L (low gear) to adjust the rear derailleur until it is vertically aligned below the lowest gear. See photo above.

Step 2:



While lifting the rear of the bike and turning the pedals by hand, use the gear shifter to select the highest gear.

Use a suitable screwdriver to turn the screw marked with H (high gear) to adjust the rear derailleur until it is vertically aligned below the highest gear. See photo above.

### Step 3:



While lifting the rear of the bike and turning the pedals by hand, use the gear shifter to change highest to the lowest gear one at a time. If the gear derailleur is adjusted correctly, the gears should shift quickly without any grinding noise.

If there are still problems after adjusting the rear derailleur, they can be further fine-tuned.

Rotate the barrel adjuster (C) clockwise if there is a problem when going from the lowest gear to the highest gear.

Rotate the barrel adjuster (C) anticlockwise if there is a problem when going from the highest gear to the lowest gear.

Turn the barrel adjuster about a quarter at a time, then change the gears again to see if the problem has been fixed. If there still is a problem, repeat the process in step 3.

### Adjusting the V-Brake Cable Tension

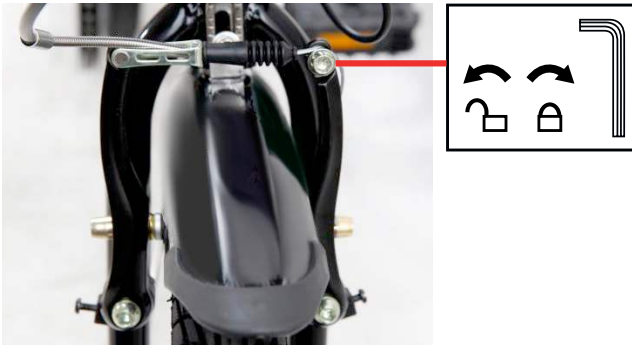

The brake cable must be adjusted so that the brakes are as close as possible to the wheel rim when no pressure is applied to the brake lever. The brake pad must be about 3 mm away from the wheel rim.

To adjust, release the bolt (see photo above) and adjust the brake cable so the brake pads are positioned correctly.

Tighten the bolt again while holding the braking cable in position.

## Fine-Tuning the Cable Tension



If the brake pads are too close or too far away from the wheel rim, they can be fine-tuned by turning the adjustment bolt to increase or decrease the brake pad distance. Turn anticlockwise to move the brake pads away from the wheel rim. Turn clockwise to move the brake pads close to the wheel rim.

## Adjusting the V-Brake Spring Tension

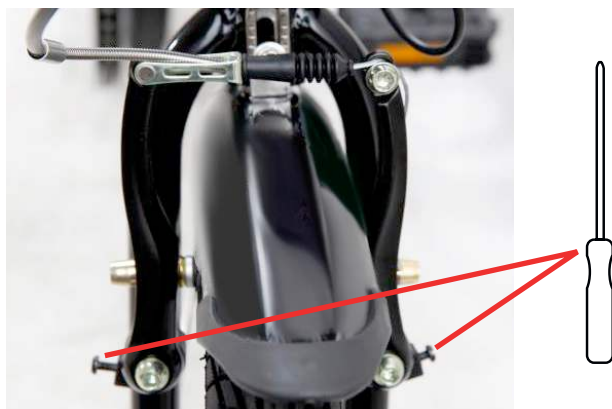

If the brake arms start to lean to one side or another, they must be corrected. The brake pads should touch the wheel rim at the same time.

Adjust by turning the spring tension screw.

Loosen the screw to move the brake arm closer to the wheel rim.

Tighten the screw to move the brake arm away from the wheel rim.

## Inspecting Wheel Trueness

Over the lifetime of the bike, the wheels may begin to run out of true.

To check the trueness of a wheel, lift the E-Bike up and spin the wheel. If the wheel wobbles from side to side, then the wheel is out of true and will need to be repaired.

Special tools are required for this repair. It is recommended that the wheels are trued by a qualified repair technician. Contact your local retailer for more information on wheel repairs.

### Inspecting Rim Wear

Each wheel features a black line wear indicator machined into the side of the rim. If the wear indicator is no longer visible, the wheel rim should be replaced immediately.

**WARNING:** If the wheel wear indicator is starting to show signs of wear, the wheel rim should be replaced immediately. Do not attempt to ride the bike until the rim is replaced as braking performance could be affected.



### Inspecting the Wheel Bearings

Over the lifetime of the bike, the wheel bearings may become worn and will need servicing. To check this, grab the tyre of either the front or rear wheel while holding the bike securely. Vigorously move the tyre from side to side. If the wheel moves at the wheel hub (the centre of the wheel), the bearing may be worn.

Special tools are required for this repair. It is recommended that the wheels are trued by a qualified repair technician. Contact your local retailer for more information on wheel repairs.

### Removing the Wheels

Release the wheel bolts on each side of the wheel.

Use the V-brake quick release.

**NOTE:** Pay attention to the position of the washers when you remove them. Attach the wheel to the washers in same order and orientation as you removed them.

**WARNING:** Remember to reattach the V-brake after attaching the wheel.

### V-Brake Quick Release

Move the protective rubber cover.

Press the brakes together and pull out the brake cable from the quick release clip.

**WARNING:** Remember to always reattach the brakes again and to test the brakes before riding the E-Bike.

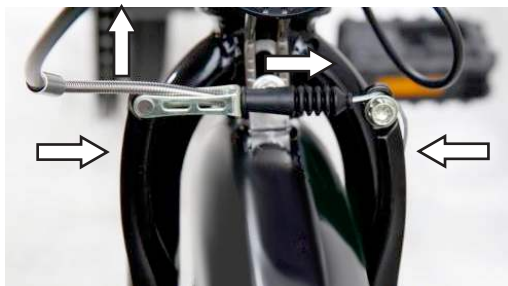

## CHANGING AN INNER TUBE

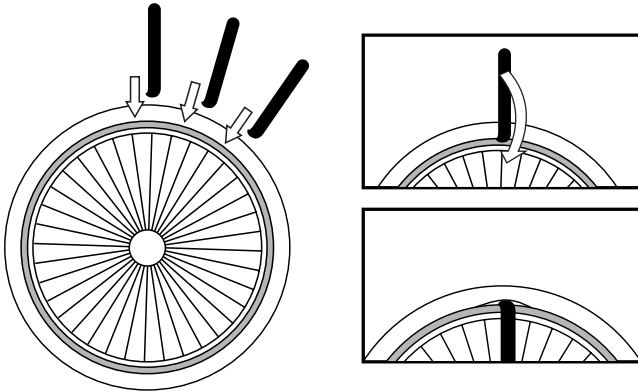

If you have a puncture, you will need to remove and patch the inner tube.

**NOTE:** A set of tyre levers is needed to remove the inner tube. Not included in the box.

Remove the dust cap from the tube valve. Deflate the tyre fully.

Push both sides of the tyre towards the centre and away from the rim to loosen the tyre. Insert a tyre lever anywhere between the tyre and the rim, but not where the tube valve is located. Insert a second tyre lever close to the first one and press it down on the tyre lever. Continue this process all around until you can remove the tyre.

After the wheel is removed, carefully remove the inner tube starting with the valve.

Check the inner surface of the tyre for any sign of damage or foreign matter.

After the tube has been repaired, partially inflate the inner tube using a bicycle pump.

Carefully feed the inner tube into the tyre, starting with the valve. The valve must be aligned with the hole in the wheel rim.

Refit the tyre in the rim, one small section at a time. For the last part, use the tyre levers to refit the last section.

## Replacing Brake Pads

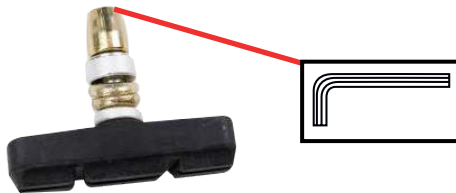

Remove the mounting bolt.

Remove the brake pad.

**NOTE:** Pay attention to the order and orientation of the spacers as you remove them.

Check the instruction of the new brake pads to find out which side to install them.

Add the replacement brake pad with the spacers in the same order and orientation as when you removed them.

## E-BIKE SPECIFICATIONS

Net weight: 18.5 kg

Max load: 100 kg

Size (folded): 82 x 42 x 68 cm

Size (unfolded): 153 x 56 x 112 cm

Wheel size: 20 x 1.75 inches

Max compatible wheel size: 20 x 1.75 inches

Weather resistance: IP54

Bike gear counts: 7

Assistance mode gear counts: 5

Max pedal assistance speed: 0-25 km/h

Boost mileage: up to 50km

## RECOMMENDED TIGHTENING INFORMATION

<b>PART</b>	<b>TORQUE (NM)</b>
<i>Front wheel bolt</i>	20-25 Nm
<i>Rear wheel bolt</i>	30-35 Nm
<i>Handlebar clamp nuts</i>	18-20 Nm
<i>Stem nuts</i>	18-20 Nm
<i>Seat Bolts</i>	18-20 Nm
<i>Seat bar nuts</i>	18-20 Nm
<i>Brake cable pinch bolt</i>	6-10 Nm
<i>Pedals</i>	17-19 Nm
<i>Crank</i>	26-28 Nm
<i>V-brake pads</i>	8-10 Nm
<i>Carrier screws</i>	4-6 Nm

## DISPLAY ERRORS

If case of electronic errors, the display will show an error code to identify the fault.

<b>CODE</b>	<b>ERROR</b>
<i>E06</i>	<i>Power failure</i>
<i>E07</i>	<i>Motor fault</i> <i>1: Loose connection 2: Motor error</i>
<i>E09</i>	<i>Controller error</i>
<i>E10</i>	<i>Communication error - sending</i> <i>1: Loose connection 2: Controller error</i> <i>3: Display error</i>
<i>E11</i>	<i>Communication error - receiving</i> <i>1: Loose connection 2: Display error</i>
<i>E30</i>	<i>Communication error</i>





Declaration of Conformity: (See provided document).  
Products marked with this symbol comply with all applicable community regulations of the European Economic Area

## DISPOSAL



Electrical and electronic equipment (EEE) contain materials, parts and substances, which can be dangerous to the environment and harmful to human health if waste of electrical and electronic equipment (WEEE) are not disposed of correctly.

Electrical and electronic equipment, which are marked with the WEEE logo (as shown on the left), should not be thrown away with your household waste. Contact your Local Authority Waste Disposal Department, as they will be able to provide details of the recycling options available in your area.



This symbol on the battery or on the packaging indicates that the battery provided with this product shall not be treated as household waste. The recycling of the materials will help to conserve natural resources. Contact your Local Authority Waste Disposal Department, as they will be able to provide details of the recycling options available in your area.

Imported by:  
Vaya Nordic ApS, Pioner Alle 16D, 9200 Aalborg SV, Denmark.  
Date of issue: 12/2022  
Version: PO-1697





